

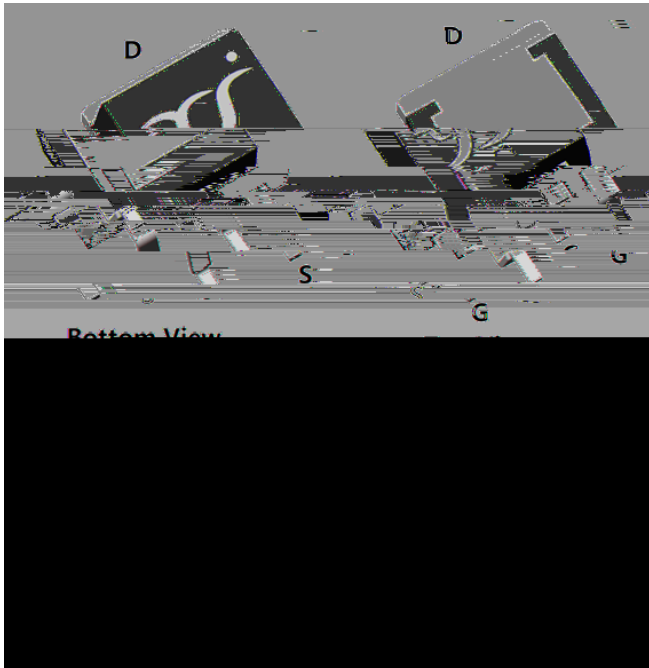

N-Channel Enhancement Mode Field Effect Transistor



Product Summary

V_{DS}	100V
I_D	130A
$R_{DS(ON)}$ (at $V_{GS}=10V$)	5m
$R_{DS(ON)}$ (at $V_{GS}=4.5V$)	6m
100% EAS Tested	
100% VDS Tested	

General Description

- Split gate trench MOSFET technology
- Excellent package for heat dissipation
- High density cell design for low $R_{DS(ON)}$
- Moisture Sensitivity Level 1
- Epoxy Meets UL 94 V-0 Flammability Rating
- Halogen Free

Applications

- Power switching application
- Uninterruptible power supply
- DC-DC \hat{A} ... = ...

	$T_A=25$	I_D	16	A
	$T_A=100$		10	
	$T_C=25$		130	
	$T_C=100$		82	
Pulsed Drain Current ^A		I_{DM}	520	A
Avalanche energy ^B		EAS	360	mJ
Total Power Dissipation ^C	$T_A=25$	P_D	2.7	W
	$T_A=100$		1.1	
	$T_C=25$		190	
	$T_C=100$		77	
Junction and Storage Temperature Range		T_J, T_{STG}	-55 +150	

Thermal resistance

Parameter	Symbol	Typ	Max	Units
Thermal Resistance Junction-to-Ambient ^D	R_{JA}			

				INNER BOX QUANTITY(pcs)	OUTER CARTON QUANTITY(pcs)	DELIVERY MODE
YJB130G10A	F2	YJB130G10A	800	/	8000	13" reel



Typical Electrical and Thermal Characteristics Diagrams

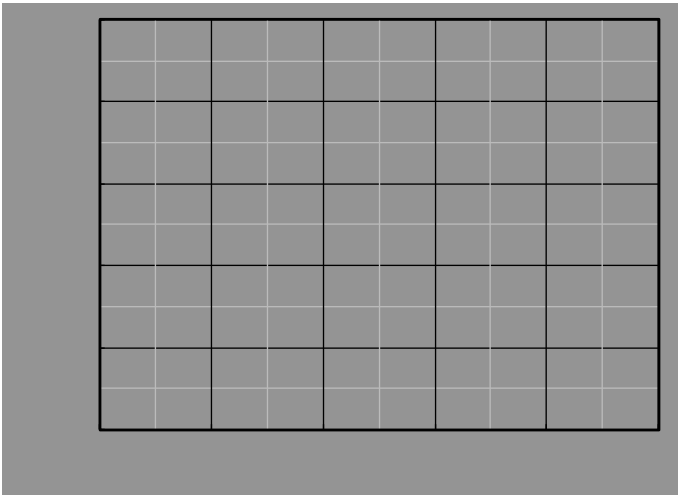



YJB130G10A

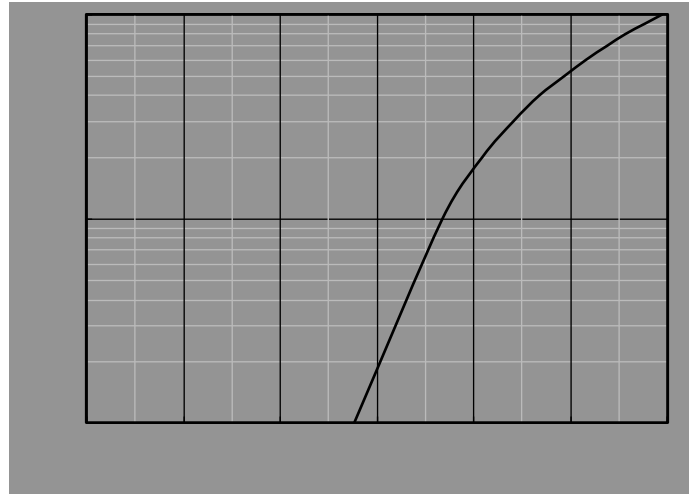
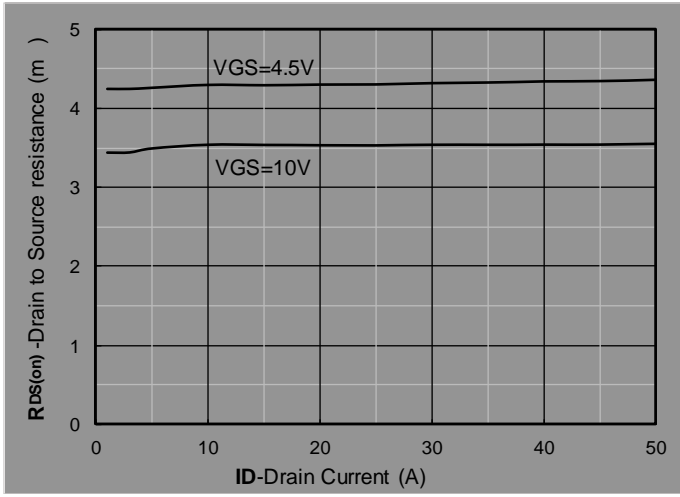

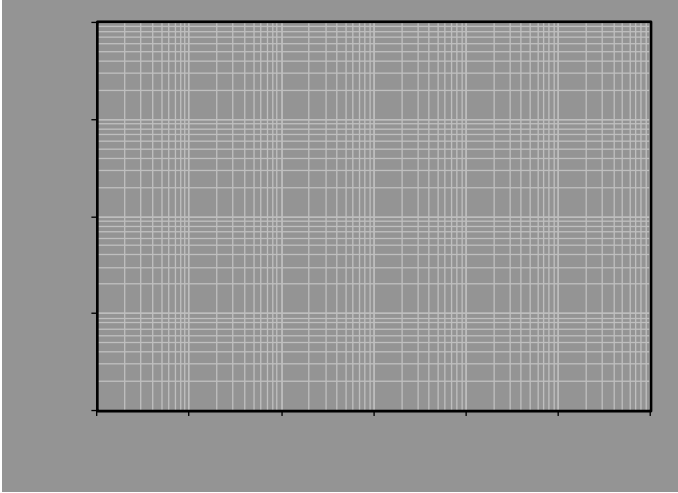



YJB130G0A

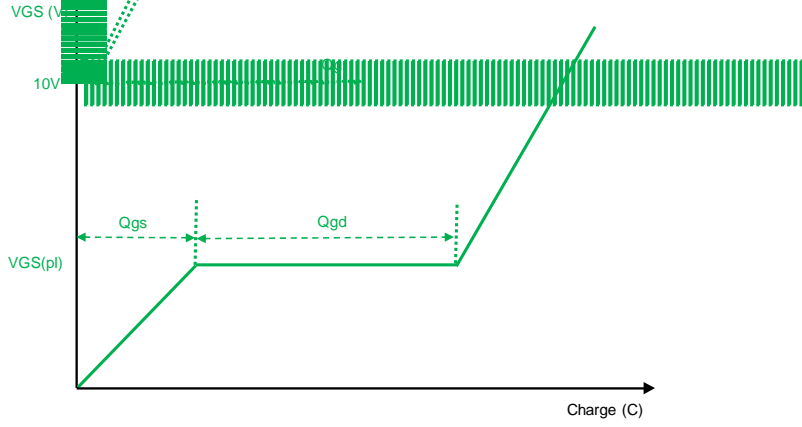
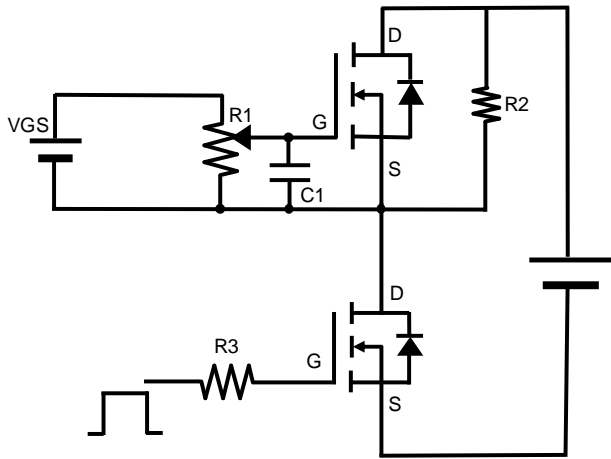



YJB130G10A

TO-263-HY Package information

TOP VIEW

SIDE VIEW

BOTTOM VIEW

SYMBOL	DIMENSIONS					
	INCHES			Millimeter		
	MIN.	NOM.	MAX.	MIN.	NOM.	MAX.
A1	0.000	---	0.010	0.000	---	0.250
A2	0.174	0.180	0.186	4.430	4.58	4.730
b	0.028	0.032	0.036	0.720		0.920
b2	0.046	0.050	0.054	1.180		1.380
c	0.013	0.015	0.018	0.330		0.450
c2	0.048	0.050	0.053	1.220		1.340
D1						
D2	0.303	0.315	0.327	7.700		8.300
E	0.571	0.591	0.610	14.500		15.500
E1	0.337	0.341	0.348	8.550		8.850
E2						
e	0.200BSC			5.080BSC		
L	0.070		0.110	1.790		2.790
L1						
L2	0.030		0.070	0.770		1.770
L3	0.197REF			0.197REF		
	0°		8°	0°		8°

NOTE:

- 1.PACKAGE BODY SIZES EXCLUDE MOLD FLASH AND GATE BURRS.
- 2.TOLERANCE 0.1mm UNLESS OTHERWISE SPECIFIED.
- 3.THE PAD LAYOUT IS FOR REFERENCE PURPOSES ONLY.



YJB130G10A

Disclaimer

The information presented in this document is for reference only. Yangzhou Yangjie Electronic Technology Co., Ltd. reserves the right to make changes without notice for the specification of the products displayed herein to improve reliability, function or design or otherwise.

The product listed herein is designed to be used with ordinary electronic equipment or devices, and not designed to be used with equipment or devices which require high level of reliability and the malfunction of which would directly endanger human life (such as medical instruments, transportation equipment, aerospace machinery, nuclear-reactor controllers, fuel controllers and other safety devices), Yangjie or anyone on its behalf, assumes no responsibility or liability for any damages resulting from such improper use of sale.

This publication supersedes & replaces all information previously supplied. For additional information, please visit our website <http://www.21yangjie.com> , or consult your nearest Yangjie's sales office